

YONGNUO

YNLUX200

摄像机灯

Pro LED Video Light

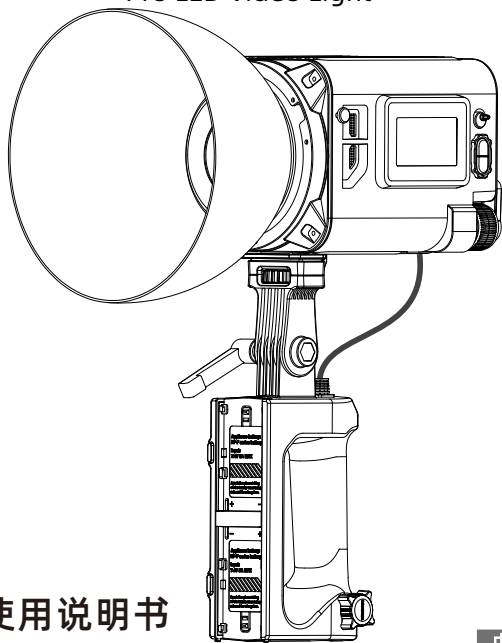

使用说明书

User Manual

中文

English

前言

感谢您使用YNLUX200摄像灯，在使用产品前，请认真阅读使用说明书。

注意事项

- 1.请妥善保管本产品，请勿让儿童接触，勿放置在儿童活动之处。
- 2.在使用产品前，请确认电源电压和本产品所标识的电压是否符合。
- 3.产品运行时，请勿遮挡散热孔，以免散热效果差从而损坏产品。
- 4.产品运行时，强光源照射，切勿直视灯珠，以免引起眼睛不适。
- 5.产品运行时，灯珠会处于发热状态，切勿触摸，以免造成烫伤。
- 6.产品保持干燥环境下使用，产品没有防水防火性能，避免在高温、雨天、潮湿、多尘的环境下使用。
- 7.请勿在化学品、可燃性气体、易燃易爆的环境下使用产品。
- 8.建议使用永诺提供的原厂线缆或出售的配件。
- 9.产品接通电源线时，请妥当放置电源线，避免绊倒人员或拉扯造成断电，勿放置在高温或潮湿表面。
- 10.产品存放前，请关机断电，拔出电源线，等待产品完全冷却后，存放至便携包或干燥环境。
- 11.在清洁产品前，确保断电状态，请使用干软布进行清洁。
- 12.产品不防摔，请小心使用，避免掉落或承受重击。
- 13.当产品出现高温报警时，请检查风扇是否出现故障。
- 14.请勿使用已损坏的电源线，以及摔落出现开裂的产品。
- 15.请勿私自拆卸产品，如出现故障须本公司或授权维修人员处理。

产品规格

光源	1颗COB灯珠		
色温	2700K-6500K		
输出功率	恒功率200瓦（色温变化，亮度不变）		
外接电池	两个NP-F系列电池或一个V口电池供电		
外接电源	DC 24V \pm 8.33A,接口尺寸 ϕ 5.5*2.1mm 		
摄像灯尺寸	18*12.5*12.5厘米		
蓝牙遥控	≤50米	2.4G无线控制	≤100米
平均寿命	50000小时	光照角度	110°

中文

物料清单

套装版

包装尺寸：43*20*32.5厘米。

所含物品：摄像灯（1）、电源适配器（1）、标准罩（1）、NP-F系列电池手柄（1）、便携箱（1）、说明书（1）。

单灯版

包装尺寸：23.5*18*16.5厘米。

所含物品：摄像灯（1）、说明书（1）。

注：如有缺失请与经销商联系。

亮度测试数据表

双色温	距离 \ 照度	裸灯	普通标准罩	龙鳞甲
2700k	1米	6720lux	15900lux	54200lux
	2米	1880lux	3650lux	12800lux
	3米	967lux	1650lux	5360lux

双色温	距离 \ 照度	裸灯	普通标准罩	龙鳞甲
5600k	1米	8440lux	20100lux	68600lux
	2米	2390lux	4700lux	16100lux
	3米	1270lux	2160lux	6760lux

双色温	距离 \ 照度	裸灯	普通标准罩	龙鳞甲
6500k	1米	8200lux	19400lux	65500lux
	2米	2310lux	4500lux	15500lux
	3米	1230lux	2030lux	6500lux

单色温	距离 \ 照度	裸灯	普通标准罩	龙鳞甲
5600k	1米	9120lux	20900lux	77600lux
	2米	2410lux	4710lux	17600lux
	3米	1260lux	2160lux	7430lux

*以上测试为平均值，不同灯的亮度有微小差异。

产品结构

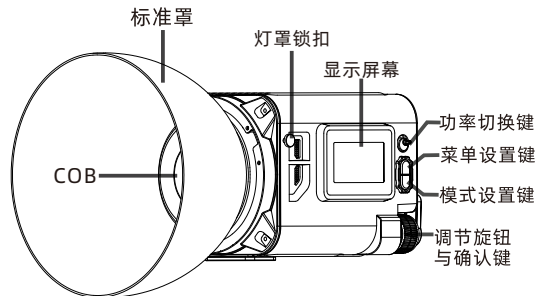

1.取下7字可调手柄与螺杆后，再按箭头方向，取下塑胶可旋转部分。

2.塑胶旋转180°插入卡口，放入螺杆再拧上7字可调手柄。

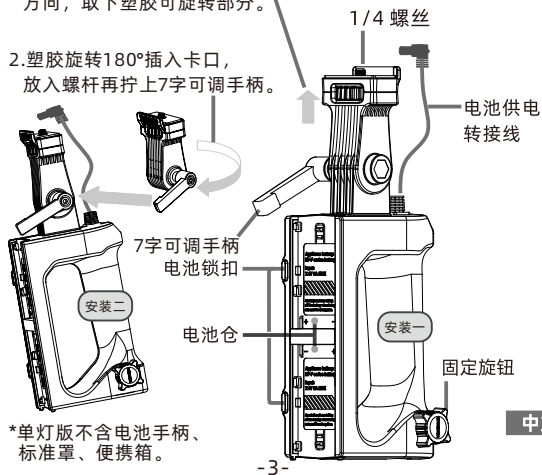

*单灯版不含电池手柄、标准罩、便携箱。

中文

-3-

安装与使用

1、供电模式。

(1).使用电源适配器供电：19~26伏时，最大功率为200瓦；
14~18伏时，最大功率为60瓦。

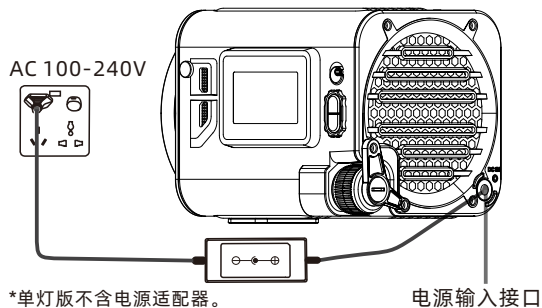

(2).使用电池供电。

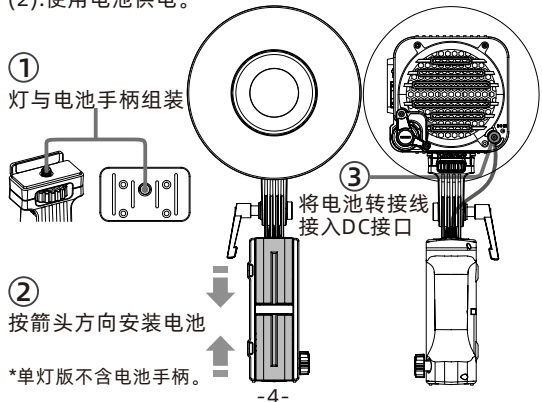

6

-4-

5

2、开机与关机。

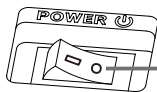

- : 开机
- : 关机

3、色温与亮度调节。

按下旋钮，切换色温与亮度调节选项，旋转旋钮调节参数。(色温调节精准至50K)

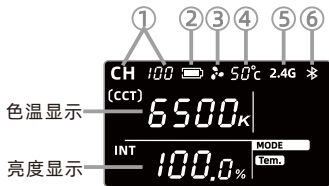
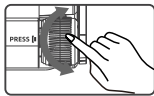

- 1: 频道显示
- 2: 电量(NP-F系列电池显示)
- 3: 风扇 (开启显示)
- 4: 灯珠温度显示
- 5: 2.4G (开启显示)
- 6: 蓝牙 (连接显示)

4、4种专业级调光曲线模型。

按下<Menu>按钮，旋转至 **M** 闪烁，按确认键停止闪烁，调节旋钮选择您所需要的曲线模型。



-5-

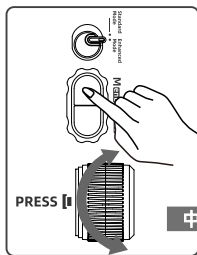

中文

5、切换频道。

按下<Menu>按钮旋转确认键选择频道[CH]菜单,按下确认键旋转旋钮调节到您所需要的频道;按下确认键完成切换。(注: CH1-CH8频道兼容永诺早期摄像灯产品,建议使用CH9以上频道,将获得更顺畅的控制体验。)

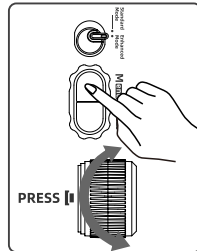
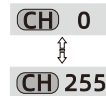

6、特效模式。

按下<Mode>按钮进入特效模式，按确认键切换特效模式、速度、亮度选项，旋转调节参数；再按下<Mode>切换到色温模式。

注：单色温版本只有9个特效模式。

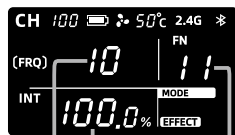

- 亮度显示
- 频率显示
- 特效显示

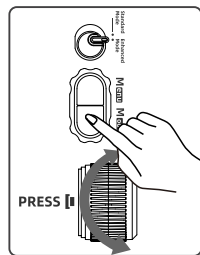

-6-



7、设置风扇开关。

按下<Menu>按钮，旋转旋钮选择风扇图标，按下确认键选择开关。

On: 风扇开起时功率200瓦。
OFF: 风扇关闭时功率降至35瓦。

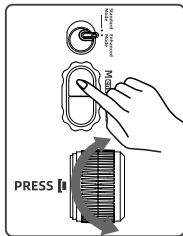

8、功率切换键。

拨动开关切换标准模式或性能模式。

	标准模式	DC 供电 100瓦	DC 供电 45瓦
	性能模式	200瓦	60瓦

中文

9、手机APP与遥控器的使用。

- 1). 按下<Menu>按键旋转调节旋钮选择蓝牙< * >, 按下确认键开启蓝牙; 此时打开手机APP就可以自动连接摄像头实现无线控制。
- 2). 2.4G无线控制模式可选择开启或关闭。
- 3). APP可以从永诺官网下载或通过扫描彩盒二维码点击下载。



蓝牙 OFF



蓝牙 ON



2.4G OFF



2.4G ON

深圳市永诺摄影器材股份有限公司

地址：深圳市坪山区坑梓街道深福保现代光学厂区A座

电话：(86) 0755-83762448

传真：(86) 0755-83762765

网址：www.hkyongnuo.com

生产地址：深圳市坪山新区坑梓街道锦绣中路14号

深福保现代光学厂区A栋厂房

售后电话：400-001-3888

本手册中的功能是依据本公司的测试条件获得，设计和规格如有变更，恕不另行通知。

Introduction

Thank you for using YNLUX200 Video light. Please read the manual carefully before you use it.

Precautions



1. Please keep product away from children, do not place it in the children's activity area.
2. Before use, please check whether the power voltage fits the voltage marked on the product.
3. When the product runs, please do not cover the dissipation hole to avoid product damage due to poor dissipation performance.
4. When the product runs, do not look straight at the lamp beads to avoid eyes discomfort due to strong lights.
5. When the product runs, lamp beads are at the heating state, do not touch it to avoid burning.
6. Use this product in dry environment. This product is not waterproof or fireproof. Do not use it in hot, rainy, damp or dusty environment.
7. Do not use this product near chemicals, flammable gases, inflammables and explosives.
8. It is recommended to use the original cables or accessories provided or sold by YONGNUO.
9. When the power cord is connected, please place it properly to avoid tripping people or blackout, and do not place it on the hot or damp surface.
10. Before storing the product, please turn off the power, unplug the power cord, wait for the product to cool down completely, and store it in a portable bag or a dry environment.

English

-9-

11. Before cleaning the product, please ensure that the power is turned off, and please use a dry soft cloth for cleaning.
12. This product is not fall-proof, please use it carefully to avoid falling down or getting heavy hit.
13. When high-temperature warning occurs, please check whether the fan is faulty.
14. Please do not use the damaged power cord or the cracked product caused by falling off.
15. Please do not disassemble the product by yourself. In case of failure, problems shall be handled by the company or authorized maintenance personnel.

Product specification

Light Source	One COB lamp bead
Color temperature version	2700K-6500K
Output power	Constant power 200W (Color temperature changes, brightness remains unchanged)
Compatible batteries	Two NP-F series batteries (Need to be purchased separately.)
External power source	DC 19V6.31A、Interface size, Ø5.5*2.1mm   
Product Net Size	18*12.5*12.5CM
Bluetooth control	≤50m
2.4G wireless control	≤100m
Average Service Life	50000H
Luminance Angle	110°

-10-

Check list

Kit version

Package Dimensions: 43*20*32.5CM.

Contents:Video light(1), Power adapter(1), standard cover(1), Battery handle(1), Prottable(1), User Manua(1).

Single light version

Package Dimensions: 23.5*18*16.5CM.

Contents:Video light (1), User Manual(1).

Note:Please contact your dealer if anything missing.

Photometrics

Bi-color temperature version	Distance Illumination	Single light	Standard Reflector	Dragon-scale Armor
		2700k	1m	6720lux
	2m	1880lux	3650lux	12800lux
	3m	967lux	1650lux	5360lux
Bi-color temperature version	Distance Illumination	Single light	Standard Reflector	Dragon-scale Armor
		5600k	1m	8440lux
	2m	2390lux	4700lux	16100lux
	3m	1270lux	2160lux	6760lux
Bi-color temperature version	Distance Illumination	Single light	Standard Reflector	Dragon-scale Armor
		6500k	1m	8200lux
	2m	2310lux	4500lux	15500lux
	3m	1230lux	2030lux	6500lux
Single color temperature version	Distance Illumination	Single light	Standard Reflector	Dragon-scale Armor
		5600k	1m	9120lux
	2m	2410lux	4710lux	17600lux
	3m	1260lux	2160lux	7430lux

* This is an averaged result, the number might be slightly different on each light.

English

Product structure

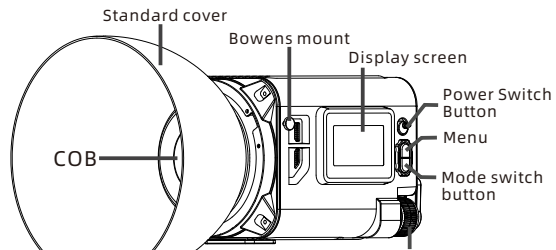

1.Remove the 7-shape adjustable handle and screw, then follow the arrow to remove the rotatable plastic part.

2.Rotate the plastic part 180° to insert into the bayonet, install the screw and then tighten the 7-shape adjustable handle.

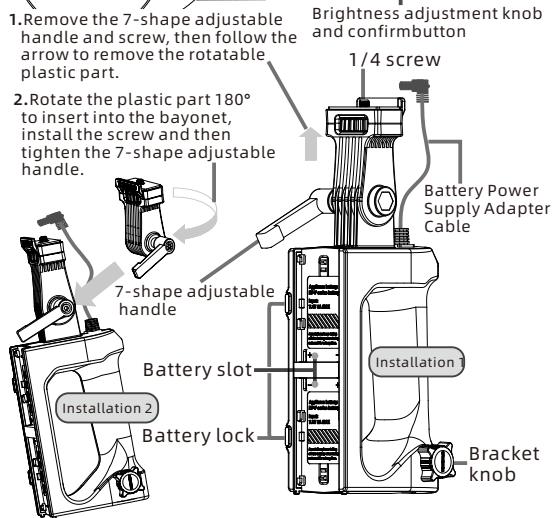

*Single light version does not contain battery handle, standard reflector or portable case.

Installation and use

1. Two power supply modes.

(1) .Powered by power adapter:

When the voltage is in the range of 19~26V, the maximum power is 200w;
When the voltage is in the range of 14~18V, the maximum power is 60w.

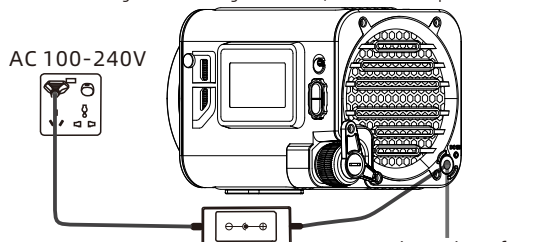

*The power adapter is not included in the single light version.

(2) .Uses battery for power supply.

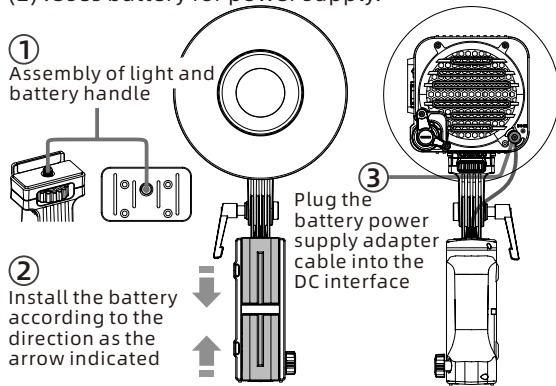

*The battery handle is not included in the single light version.

English

2. Power ON or OFF.

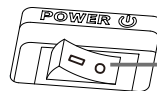

— : ON

○ : OFF

3. Color temperature and brightness adjustment.

and press the knob to switch the color temperature and brightness options, rotate the knob to adjust the parameters. *Color temperature is adjusted accurately to 50K.

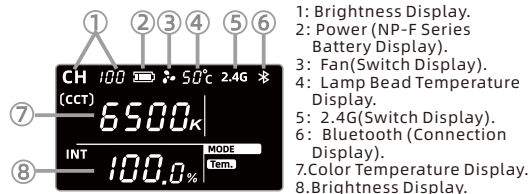

4.4 professional light adjustment curve models.

Press the <Menu> button, rotate to **M** blinking, press the CONFIRM key to stop blinking, adjust the knob to choose the curve model you need.

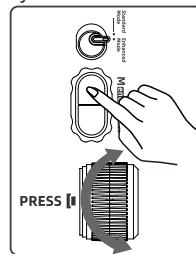

1 Exponential



2 Logarithmic



3 S-shaped



4 Linear

5. Switch channels.

Press the button <Menu> and toggle the confirm button to select the channel [CH] menu, then turn the knob to adjust the channel you want; press OK to complete the switch. (Note: The product provides 256 channels.)



CH 0



CH 255

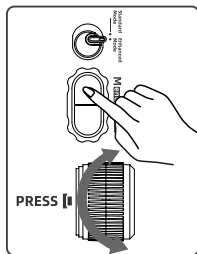

6. Special effect mode.

Press <Mode> button to enter special effect mode, press confirm button to switch the special effect mode, speed and brightness options, turn the knob to adjust the parameter. Press <Mode> again to switch to the color temperature mode.

(Note: 9 special modes for white version)

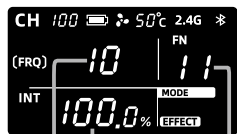

Special Effects Display
Brightness Display
Frequency Display

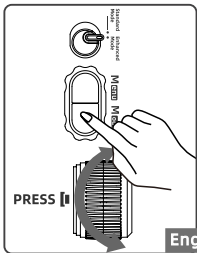

English

-15-



Simulated lightning



Film screen reflection



Paparazzi



Strobe



SOS



White breathing light



The explosion



Fireworks



The bad light bulb



Sunrise



Yellow breathing light



Temperature cycle

7. Fans Switch Setting.

Press the <Menu> button, and then rotate the knob to select the fan icon, and press the confirm button to select the switch.

ON: The power is 200W when the fan is on.

OFF: The power is reduced to 35 Watts when the fan is off.

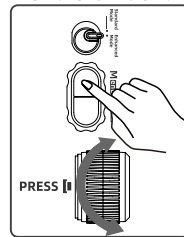

8. Power Switch Button.

Toggle the power to switch between standard mode and performance mode.

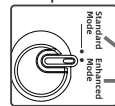

	DC input	Battery
Standard Mode	100W	45W
Enhanced Mode	200W	60W

-16-

9. Use via mobile APP and remote control for wireless control.

1). Press the menu button < * > and toggle the OK button to select bluetooth, press OK button to turn on bluetooth; open the mobile APP , at this time the video light is connected automatically to realize wireless control.

2). 2.4G wireless control mode can be selected to turn on or off.

3) The APP can be downloaded from the YONGNUO official website or scanning the QR code on the gift box.



Bluetooth
OFF



Bluetooth
ON



2.4G OFF



2.4G ON

The functions in this manual are based on the test conditions our company. Further notice will not be given if the design and specifications change.



APP下载

APP Download



永诺官网

YONGNUO Web

English